

Ashley

America's Hearth Since 1905

2024 Catalog



WOOD STOVES

Freestanding · Inserts



Product shown: TH-100

Key Category Features

High Heat Output

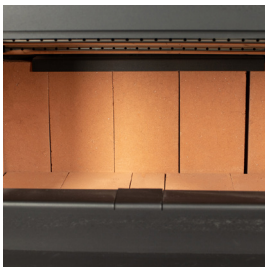

Firebrick lined stoves increase heat retention & appliance lifespan

Non-Catalytic Secondary Burn

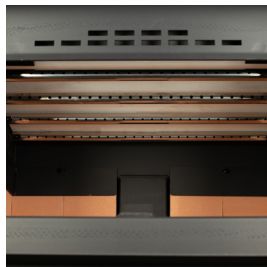

Hassle free burn tubes produces less ash & needs less maintenance

High Quality Materials



Premium steel and cast iron = longer product life and heat retention

Large Viewing Windows



Large windows provide radiant heat and pleasing aesthetics

WOOD STOVES

Freestanding · Inserts



TH-100 HEATS UP TO 750 SQ. FT.

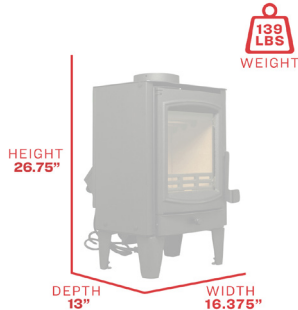
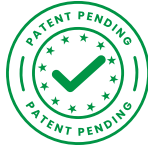

- Up to 26,000 BTU's
- Up to 11" log length
- 6" Flue pipe diameter
- Optional blower - CB36
- Mobile Home Approved with Fresh Air Kit - 4FAK



30% TAX CREDIT

US1269E HEATS UP TO 900 SQ. FT.

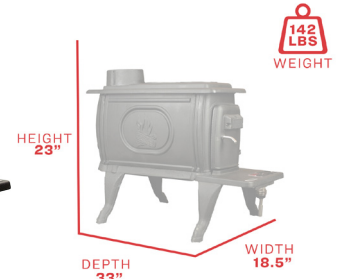

- Up to 54,000 BTU's
- Up to 19" log length
- 6" Flue pipe diameter
- Built in cook top
- Cast Iron construction

US1261E HEATS UP TO 900 SQ. FT.

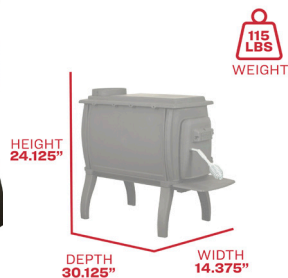
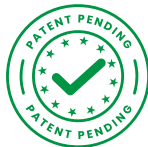

- Up to 54,000 BTU's
- Up to 19" log length
- 6" Flue pipe diameter
- Built in cook top
- Cast Iron construction
- *Optional side tables available (US1261DST)



AW1120E-P HEATS UP TO 1,200 SQ. FT.

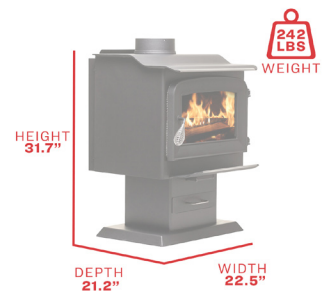

- Up to 68,000 BTU's
- Up to 18" log length
- 6" Flue pipe diameter
- Optional blower - CB36
- Mobile Home Approved with Fresh Air Kit - 4FAK

WOOD STOVES

Freestanding · Inserts

Ashley
America's Hearth Since 1905

AW1820E

HEATS UP TO 1,200 SQ. FT.

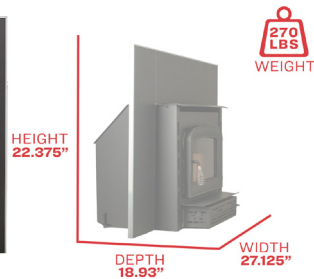

Up to 69,000 BTU's
Up to 18" log length
6" Flue pipe diameter
150 CFM Blower included
Wood insert designed for masonry fire places only

AW2020-P

HEATS UP TO 2,000 SQ. FT.



Up to 89,000 BTU's
Up to 21" log length
6" Flue pipe diameter
Optional blower - CB36
Mobile Home Approved with Fresh Air Kit - 4FAK

AW2520E-P

HEATS UP TO 2,500 SQ. FT.



Up to 112,800 BTU's
Up to 21" Log length
6" Flue pipe diameter
Optional blower - CB36
Mobile Home Approved with Fresh Air Kit - 4FAK

AW3200E-P

HEATS UP TO 3,200 SQ. FT.

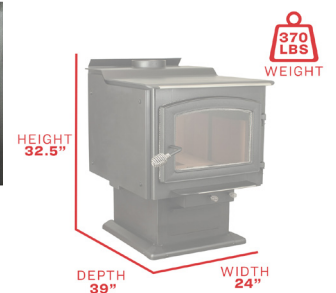

Up to 152,000 BTU's
Up to 18" log length
6" Flue pipe diameter
Blower included
Mobile Home Approved with Fresh Air Kit - 4FAK

30% TAX CREDIT

PELLET STOVES

Freestanding · Inserts · Wall Mount



Product shown: AP5622

Key Category Features

Remote Operation

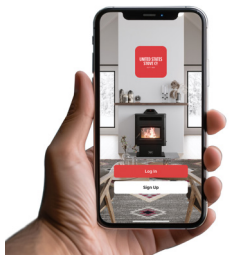

Select models include Wi-Fi + Bluetooth technology

High Efficiency Burn Pots



Increases the airflow and heat output

Ceramic Glass



High heat tolerance glass increases efficiency & enhances aesthetics

PID Technology



Stove automatically maintains desired temperature by feeding/restricting fuel
* Select stoves only

PELLET STOVES

Freestanding · Inserts · Wall Mount



Built in **Wi-Fi + Bluetooth** Connection

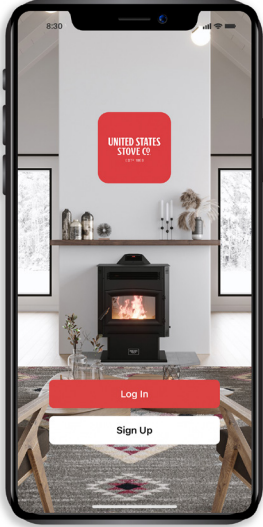

Download our app for Android or iPhone

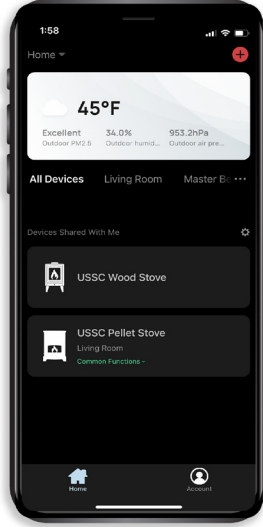

Easily connect to multiple devices

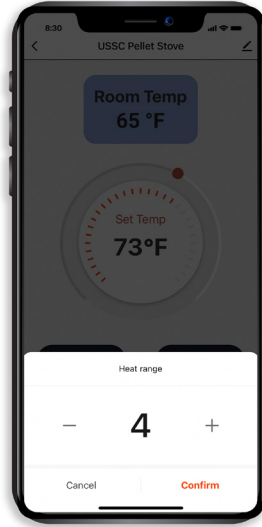

Adjust your stove from anywhere

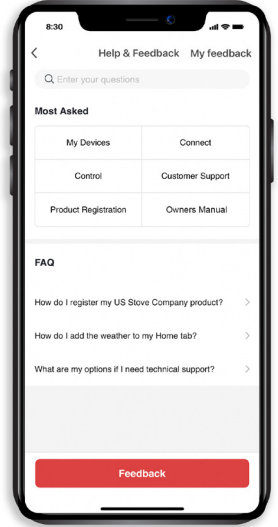

Easily access manuals and register your product



PELLET STOVES

Freestanding · Inserts · Wall Mount



AP5613-W HEATS UP TO 1,300 SQ. FT.



Up to 25,000 BTU's
50 lb. hopper capacity
Up to 30 Hour burn time
Remote operation through App
Mobile Home approved with the use of the optional fresh air kit - 69FAK



AP5617-W HEATS UP TO 1,700 SQ. FT.

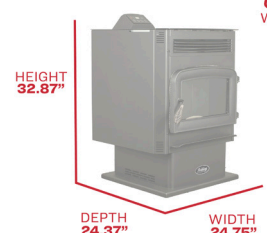

Up to 30,000 BTU's
90 lb. hopper capacity
Up to 47 hour burn time
Remote operation through App
Mobile Home approved with the use of the optional fresh air kit - 69FAK



AP5622-W HEATS UP TO 2,200 SQ. FT.

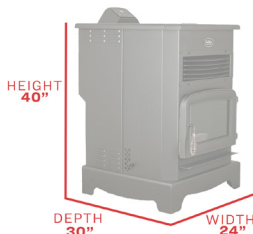

Up to 33,000 BTU's
170 lb. hopper
Up to 80 hour burn time
Remote operation through App
Mobile Home approved with the use of optional fresh air kit - 69FAK



AP5780E HEATS UP TO 2,200 SQ. FT.



Up to 48,000 BTU's
46 lb. hopper
Up to 32 hour burn time
Remote control included
Mobile Home approved with the use of optional fresh air kit - 69FAK



PELLET STOVES

Freestanding · Inserts · Wall Mount



GW1949 HEATS UP TO 2,000 SQ. FT.

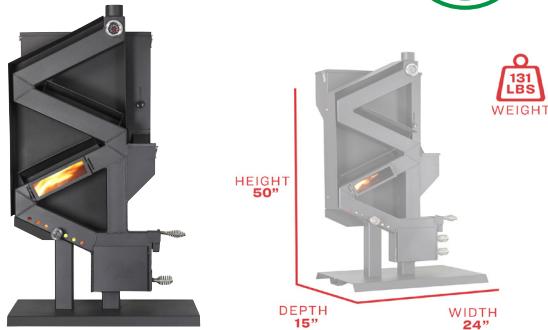

- Up to 40,000 BTU's
- 60 lb. hopper
- Up to 36 hour burn time
- Patented gravity fed, non-electric pellet stove design
- Silent operation
- Mobile Home approved with the optional fresh air kit - 69FAK

AP5660 HEATS UP TO 2,200 SQ. FT.



- Up to 48,000 BTU's
- 45 lb. hopper
- Up to 30 hour burn time
- Ash pan included
- Remote control included
- Mobile Home approved with the optional fresh air kit - 69FAK

5040 HEATS UP TO 1,800 SQ. FT.



- Up to 40,000 BTU's
- 45 lb. hopper
- Up to 45 hour burn time
- Blower included
- Mobile Home approved use of the optional fresh air kit - 69FAK

5040I HEATS UP TO 1,800 SQ. FT.



- Up to 40,000 BTU's
- 45 lb. hopper
- Up to 45 hour burn time
- Blower included
- Mobile Home approved use of the optional fresh air kit - 69FAK

PELLET STOVES

Freestanding · Inserts · Wall Mount



6041

HEATS UP TO 2,000 SQ. FT.



Up to 52,000 BTU's
60 lb. hopper
Up to 36 hour burn time (pellets)
Up to 25 hour burn time (corn)
Multi-Fuel capable
Mobile Home approved use of the optional fresh air kit - 69FAK

6041I

HEATS UP TO 2,000 SQ. FT.

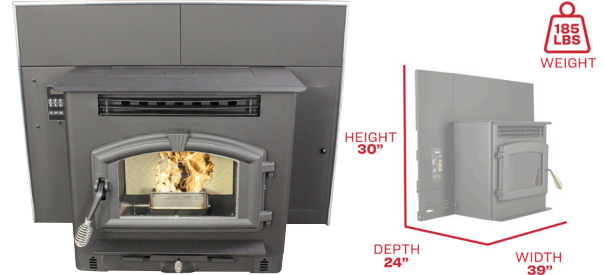

Up to 52,000 BTU's
60 lb. hopper
Up to 36 hour burn time (pellets)
Up to 25 hour burn time (corn)
Multi-Fuel capable
Mobile Home approved with the optional fresh air kit - 69FAK

AP5000

HEATS UP TO 1,000 SQ. FT.



Up to 12,000 BTU's
28 lb. hopper
Up to 35 hour burn time
Patented design for wall mounting to save floor space
Includes all venting and materials for complete installations
Mobile home approved

AV15E ASH VACCUM



3 layer fine dust filter with mesh cage
Plastic crevice tool
3.25 foot suction hose with 8 inch aluminium wand
Darcon pre filter bag
AVPK replacements filter & parts kit available

COAL STOVES & CIRCULATORS

Wood Burning · Coal Burning



Product shown: AW40

Key Category Features

Heavy Duty Construction



SR75E

For longer life and a more complete combustion

Less Maintenance



BCAC

Accessible access points for easy maintenance

Large Capacity



1869

Long burn times with fewer refuels

Steady Heat Output



AW40

Non-catalytic, operating system that is thermostatically controlled

COAL STOVES & CIRCULATORS

Wood Burning · Coal Burning



1869 HEATS UP TO 1,500 SQ. FT.



- Up to 80,000 BTU's
- 40 lb. Coal capacity
- 8" Cook top
- Cool touch spring handle
- Draft controls on feed and ash doors
- Coal burning only

SR57E HEATS UP TO 1,000 SQ. FT.



- Up to 60,000 BTU's
- 0.75 Cu. Ft. firebox
- Four 8" Cook tops
- Features a cast iron shaker grate and large ash pan for easy ash removal
- Coal burning only

AW40 HEATS UP TO 2,000 SQ. FT.



- Up to 93,000 BTU's
- 21" Log capacity
- Blower included
- Firebrick lined
- 6" Flue pipe diameter
- Top opens to expose cooking surface
- Wood burning only

BCAC HEATS UP TO 2,000 SQ. FT.



- Up to 110,000 BTU's
- 60 lb. Coal capacity
- Shaker grates
- Optional blower - CB36
- 6" Flue pipe diameter
- Top opens to expose cooking surface
- Coal burning only

FURNACES

Wood Burning · Coal Burning



Product shown: HB1520

Key Category Features

Superior Heat Output



Outputs up to 25% more heat than the competitors

Whole Home Coverage



Can heat up to 3,500 sq. ft. using existing HVAC system

Heating Efficiency

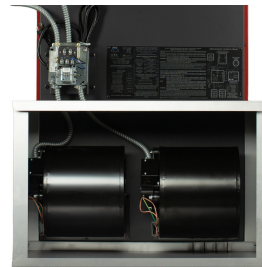

Dual CFM 500 blowers provide more efficient and consistent heating

IRS Tax Rebate



Select furnaces qualify for the IRS (25C) 30% Energy Residential Tax Credit

FURNACES

Wood Burning • Coal Burning



1500 HEATS UP TO 2,500 SQ. FT.

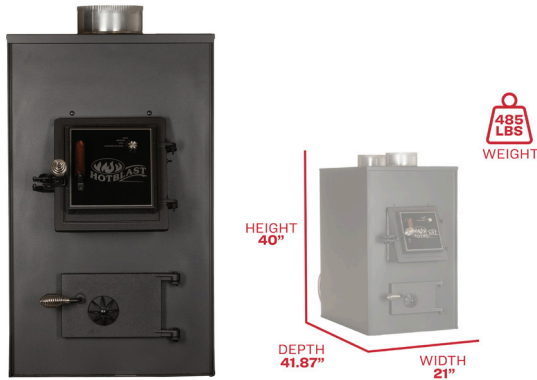

- Up to 139,000 BTU's
- 6" Flue pipe diameter
- Dual 8" diameter heat outlets
- Dual 500 CFM Blowers
- Removable/replaceable shaker grates with handle included



HB1520 HEATS UP TO 3,500 SQ. FT.



- Up to 180,000 BTU's
- 6" Flue pipe diameter
- Accepts up to 23" logs
- Dual 550 CFM Blowers
- Dual 8" diameter heat outlets



COAL FURNACE ACCESSORIES

1508 ASH BUCKET



- 6 gallon capacity
- Tight fitting lid with handle
- Safe removal and storage of ashes
- Darcon pre filter bag
- Safe removal and storage of ashes

WOOD FURNACE ACCESSORIES

USLRK LOG RACK BRACKET KIT



- Heavy duty steel construction
- Includes 4 brackets to create your own log rack
- For use with 2x4 lumber (not included)

Direct Vent Gas Heaters

Dual Fuel • Propane • Natural Gas



Product shown: DVAG8

Key Category Features

Sealed Combustion



Fresh air intake creates a safe and efficient combustion system

No Electricity Required



Matchless piezo ignition & top mounted controls requires no electricity

Clean Burning



Produces less emissions compared to wood burning appliances

Vent Kit Included



Complete venting kit included for easy installation

Direct Vent Gas Heaters

Dual Fuel • Propane • Natural Gas



DVAG8

HEATS UP TO 300 SQ. FT.
SINGLE FUEL ONLY



Up to 5,700 BTU's
Sealed combustion system
Matchless piezo ignition
Venting kit included

Fuel Tupe Model Numbers:

DVAG8L: Propane
DVAG8N: Natural Gas

DVAG11

HEATS UP TO 375 SQ. FT.
DUAL & SINGLE FUEL AVAILABLE



Up to 11,000 BTU's
Sealed combustion system
Matchless piezo ignition
Venting kit included

Fuel Tupe Model Numbers:

DVAG11L: Propane
DVAG11N: Natural Gas
DVAG11-DF: Dual Fuel **NEW**

DVAG17

HEATS UP TO 570 SQ. FT.
DUAL & SINGLE FUEL AVAILABLE



Up to 17,000 BTU's
Sealed combustion system
Matchless piezo ignition
Venting kit included

Fuel Tupe Model Numbers:

DVAG17L: Propane
DVAG17N: Natural Gas
DVAG17-DF: Dual Fuel **NEW**

DVAG25/DVAG30

HEATS UP TO 850 SQ. FT.
DUAL & SINGLE FUEL AVAILABLE



Up to 25,000 BTU's
Sealed combustion system
Matchless piezo ignition
Venting kit included

Fuel Tupe Model Numbers:

DVAG30L: Propane
DVAG30N: Natural Gas
DVAG25-DF: Dual Fuel **NEW**

GAS STOVES

Inserts



AGVF340LP
HEATS UP TO 1,200 SQ. FT.

AGVF340N
HEATS UP TO 1,200 SQ. FT.



Up to 34,000 BTU's
Vent free for easy installation
Log set included
Comes with 1 ft. gas hookup hose
Propane fuel only

NEW

Up to 34,000 BTU's
Vent free for easy installation
Log set included
Comes with 1 ft. gas hookup hose
Natural gas fuel only

NEW

Ashley

America's Hearth Since 1905

Why choose Ashley for your heating needs?



For 150+ years, we've been America's go-to for reliable and high quality heating solutions.



With an average tenure of 10 years, our experienced staff offer customers lasting support and industry expertise.

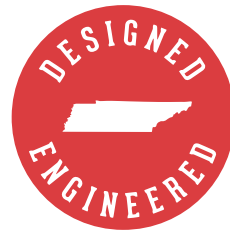

We pride ourselves on innovation and quality products, ensuring all standards are met at our corporate HQ in South Pittsburg, TN.



Our company strives for operational excellence and leads the way in logistics, and supply chain management.



OUTDOOR LIVING

Firepits • Camp Stoves • Barrel Stove Kit



Products shown: BSK 1000, CCS14, USSLP31

Key Category Features

Performance



USSLP31

Exceptional heat performance for comfortable outdoor warmth

Sustainability



USSLP21

Utilizes renewable resources for fuel.

Portability



CCS14 Carry Bag

Easily move and position where warmth is needed.

Easy Setup



CCS18

Easily create warmth without complex tools.

OUTDOOR LIVING

Firepits • Camp Stoves • Barrel Stove Kit

Ashley
America's Hearth Since 1905

USSLP21 21" SMOKELESS FIREPIT



Secondary combustion system
Fits up to 17" logs
Patented burner allows for longer burn times
Included custom ash shovel for easy clean up (model USSLP-AT)

USSLP31 31" SMOKELESS FIREPIT

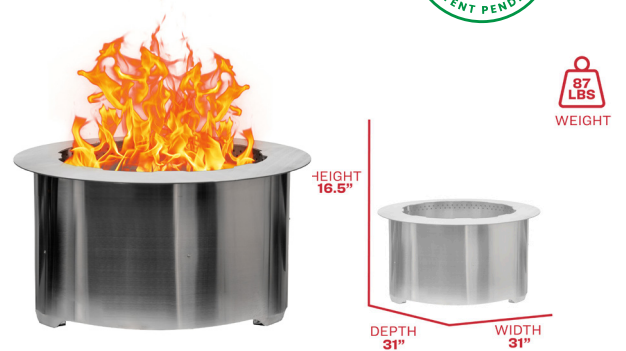

Secondary combustion system
Fits up to 25" logs
Patented burner allows for longer burn times
Included custom ash shovel for easy clean up (model USSLP-AT)

BSK1000 CAMP STOVE KIT



Heavy duty cast iron
6 In. flue pipe diameter
Light weight and portable
Fits 55-gallon steel drum
Camp stove - not for residential use

BKAD500 Adapter kit available

**Steel Drum Sold Separately:
Model Number DR55**

CCS14 & CCS18 PORTABLE CAMP STOVE



6.2 Ft. Chimney Height
Heavy duty steel construction
Flat top surface provides cooking area
2 Multi-Purpose shelf/drying rack
Includes carry bag, flue brush, & damper tool

Not for residential use

CCS14: Fits up to 13" logs
Dimensions: 15.6"H x 14"D x 10.8"W (17 lbs)

CCS18: Fits up to 16.5" logs
Dimensions: 16.5"H x 18"D x 13.8"W (21 lbs)

PARTS & ACCESSORIES

Firebrick · Dampers · Grates · Fans · Steamers · Blowers



Product shown: MH4

Key Category Features

Built to Last



Crafted with high-quality materials and precision engineering

Tried and True



All Parts & Accessories are compatibility-tested for a perfect fit

Consistent Performance



USSC parts and accessories ensure consistent, reliable performance

1 Year Warranty



All of our parts come with a 1 Year Limited Warranty

PARTS & ACCESSORIES

Firebrick · Dampers · Grates · Fans · Steamers · Blowers



MH4 MIRACLE HEAT FAN



Thermoelectric fan powered by heat from stove

High quality anodized extruded aluminium material

Operating temperature range: 140°F (60°C) - 644°F (340°C)

Silent operation

Evenly distributes heat

FBP6 FIREBRICK (6 PACK)



Increases efficiency

Can be used in any brand of wood or coal stove that uses this standard sized brick

Also great for use in fire pits, smokers, etc

Standard size firebrick
4-1/2 in. x 9 in. x 1-1/4 in

***Compatible with all wood stoves and furnaces**

D6 & D8 STOVE DAMPER

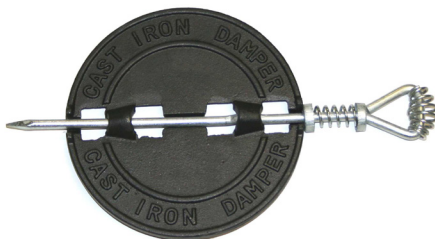

Made from heavy cast iron

Genuine USSC parts

Easy installation

REPLACEMENT GRATES MODELS: G26, 55G, G42, G15

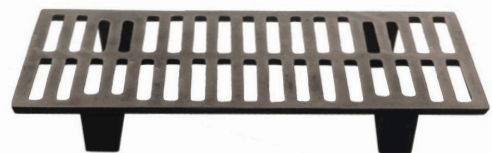

All cast iron for years of use

Raises wood for better combustion

Helps air circulate underneath the wood to feed the fire

Improves burn cycle

***Not for use in EPA certified wood stoves**

PARTS & ACCESSORIES

Firebrick · Dampers · Grates · Fans · Steamers · Blowers



CS-01 CHICKEN STEAMER



Steaming hot water adds humidity in the room

All cast iron construction for years of service

One (1) quart capacity

Compatible with wood and coal stoves

Not for drinking water

TK-02 TEA KETTLE STEAMER



Steaming hot water adds humidity in the room

All cast iron construction for years of use

Cool touch chrome spring handle

Three quart capacity

Compatible with wood and coal stoves

Not for drinking water

MH6 HEAT RECLAIMER



Fully automatic operation

Easy installation

Fully sealed from flue gassed

Install 15 to 24 in. away from stove

Not for use with oil and gas furnaces

Compatible with all wood and coal stoves with 6" Flue

CB36 BLOWER FAN



Compatible with all blower equipped or blower optional USSC stoves

100 CFM blower

Genuine USSC parts

All mounting hardware Included

Designed to circulate room air around the firebox to heat the room faster

WOOD FUEL

Heating · Cooking · Smoking Chunks · Kiln Dried Firewood



Key Category Features

Premium Hardwood



Sourced from American mills, and hand picked from US Stove Co.

Triple Filtered



Our pellets are all triple filtered to ensure ideal burn and less jams

No Binders or Fillers



Our pellets are made solely through the heat and pressure

Low Moisture



Low moisture content ensures ideal combustion conditions

WOOD FUEL

Heating · Cooking · Smoking Chunks · Kiln Dried Firewood



USHP40 PREMIUM HEATING PELLETS



- 40 lb bag
- 100% Natural Hardwood
- 100% Renewable
- Low Ash and Moisture Content
- No Additives
- No Binders
- Clean Burning



COMPETITION PREMIUM COOKING PELLETS



- 20 lb bag
- Exceptional flavor and consistent performance
- 100% Natural Hardwood
- No Binders or Fillers
- No Additives
- Clean Burning

Model Number: USCP20-C



FLAVORED PREMIUM COOKING PELLETS



- 20 lb bag
- Exceptional flavor and consistent performance

Available Flavors:

- Hickory: USCP20-H
- Apple: USCP20-AP
- Mesquite: USCP20-M
- Bourbon: USCP20-BB
- Cherry: USCP20-CH



USLC10 PREMIUM SMOKING CHUNKS



- 10 lb. bag
- Hand selected premium hardwoods
- Perfect for grilling or smoking
- Exceptional aroma and taste
- Long-lasting smoke



USBB10 BOURBON SMOKING CHUNKS



- 10 lb. bag
- Authentic bourbon barrel staves
- Hand picked
- Perfect for grilling or smoking
- Exceptional aroma and taste



USFWO-8 KILN DRIED OAK FIREWOOD



- 8 pack
- High quality oak
- High heat output
- Kiln dried for low moisture



Ashley

America's Hearth Since 1905

Since 1905, Ashley has provided warmth and comfort to homes across America for generations.

As a company founded on family values, craftsmanship and hard work we are proud to continue these traditions to the next generation of families. The Ashley Hearth brand has been part of the US Stove family for over 20 years.



Scan to download our App!



GET IT ON
Google Play



Download on the
App Store

UNITED STATES
STOVE CO.

EST. 1889

usstove.com | 1.800.750.2723

©2024 United States Stove Company
All Rights Reserved